



★
DT 200
Options
★ ON PAGE 21 ★

Equipment Catalog
800-825-3346 Sales@LeeAgra.com

Send us your cool pics!



We'll send you a cool hat!

Click Here!

Or visit LeeAgra.com/Promos to learn more!



Table Of Contents

DT 475 Diesel Trailer	6
DT 975 Diesel Trailer	7
D.O.T. 500 Diesel Trailer	8
D.O.T. 990 Diesel Trailer	9
DT 100 Portable Tank	10
DT 200 Portable Tank	11
DT 200 w/ Fill-Rite 13GPM Pump	12
DT 200 w/ Fill-Rite 20GPM Pump	13
DT 200 w/ Fill-Rite Hand Pump	14
DT 2x100 Portable Tank	15
DT 200 Cart	16
DT 200 Trailer	17
DT 500 Portable Tank	18
Refueling Parts	19
Lights and Trailer Parts	20
DT 200 LEE Installed Options	21
DT 200 Customer Installed Kits	21
DT 200 Replacement Parts	21
Fill-Rite Products	22
Assembled Fill-Rite Pump Kits	23
LoadSABER LS2	24
LoadSABER LS1	25
LEE LoadSABER Rack	26
BOSS Quick Hitch	27
BOSS Models	28
BOSS Cat-3 Sideswipe	29
BOSS Quick Hitch Rack	30
Quick Hitch Dimensions	31
BOSS 3-Point Hitch Pins	32
BOSS 3-Point Hitch Pin Kits	33
Battery Boxes	33
Decals	34
Gear	35
Terms and Conditions	36
Notes	37



THE BEST DIESEL FUEL TRAILER ON THE MARKET TODAY



LEE Diesel Fuel Trailers are designed by expert engineers and assembled by master craftsmen who make safety and durability their highest priority to create the best diesel fuel trailers on the market today.

Round Is Best.

Any fuel tank on the market utilizing the square design suffers from a major design flaw. During transport, fuel surges forward and back and from side to side. This behavior stresses the 90° welds and distends the flat surfaces inherent in the square design.

The superior round design minimizes this effect by allowing the fuel to roll up the edges thereby distributing the stress evenly around the tank and increasing the safety of the tank during transport. For this reason fuel distributors use the round tank design for all 18-wheel fuel transports.

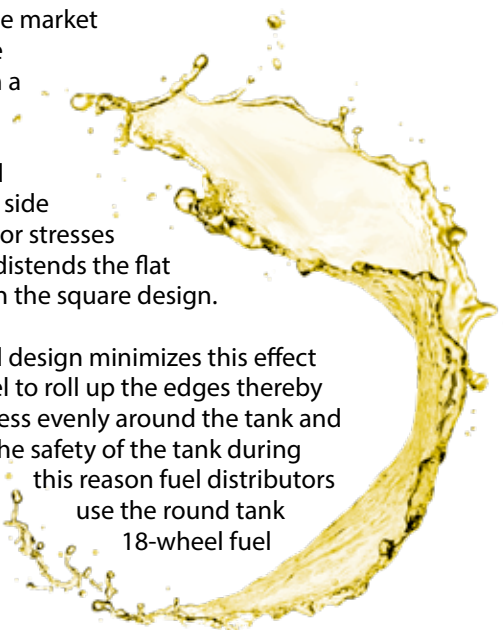

FILL-RITE®

The Most Trusted Name in Pumps and Meters

Tuthill Fill-Rite is the most trusted name in pumps and meters and we are proud say Fill-Rite pumps now come standard on all LEE diesel fuel trailers and tanks. We now offer a growing line Tuthill Fill-Rite products.



Each diesel fuel trailer from Lee comes equipped with tandem Dexter Torflex® axles. The independent wheel suspension and self-damping action provides improved suspension characteristics.

The parts to be coated are positively grounded, so that the charged particles adhere to them until melted and fused into a solid coating in a curing oven. The result: a sleek, strong, high-quality finish.



LEE Equipment Catalog • 800-825-3346 • Sales@LeeAgra.com

Prices and specifications are subject to change without notice. FOB Lubbock, Texas. Prices effective December 16, 2022. LeeAgra, Inc • 117 E. 70th St. Lubbock, TX 79404

LEE DFT Advantage

Brakes Standard

Brakes on one axle are standard for all DT 475 and DT 975s.

Battery/Toolbox

The locking steel toolbox now also protects the battery and your extra equipment from the elements.



Circular Design

Unlike square tanks, round tanks distribute the stress of surging diesel evenly around the tank.

Dished Flanged Ends

The radius of the dished ends is formed instead of welded which decreases the stress points. During starts and stops diesel fuel rolls up the ends instead of surging forward and back. This reduces stress on the tank, trailer and tow vehicle.

Heavy Duty Suction Pipe

Standard suction pipes can break with the movement of fuel in the tank. Our custom suction pipes are the strongest on the market and will never need repair.

Rigid Trailer Frame

Heavy duty trailer frame withstands the toughest conditions on any farm and dirt roads.



Refueling Access

All refueling components, fuel pump, fuel gauge, and fuel cap are placed in one easy to access location at the top and rear of the trailer.

Highly Visible

Low-profile, square fuel trailer designs cannot be seen through the rear-view mirror while backing up. Lee diesel fuel trailers are highly visible in your rear-view mirror which increases safety while backing.

Rubber Torsion Axles

Rubber cushioning eliminates metal-to-metal contact and reduces road shock for better cargo protection. The torsion arm is forged for maximum strength.

Powder Coating

The powder coating creates a durable long-lasting high-quality finish.

Baffle System

Inside the tank, a heavy-duty baffle system keeps the motion of the fuel to a minimum.



Rollover Protection System*

A heavy duty roll cage protects the fuel pump and inlet valve in the event of a rollover.
*D.O.T. line of fuel trailers.

Rear Bumper

The rear bumper provides a sturdy platform for accessing the fuel nozzle.

Diamond Plate Fenders

Heavy-duty fenders provide a sturdy service platform and protect the tank and tow vehicle from debris during transport.



LEE Equipment Catalog • 800-825-3346 • Sales@LeeAgra.com

Prices and specifications are subject to change without notice. FOB Lubbock, Texas. Prices effective December 16, 2022. LeeAgra, Inc • 117 E. 70th St. Lubbock, TX 79404



DT 475 Diesel Trailer

DT 475

Features

- Dished Flanged Ends
- Baffle System
- Visible While Backing
- Tank Is Compatible For Use With Class 3 Combustible Materials
- Unit Is Manufactured For Farm Use



DT 475	500-Gal. Diesel Fuel Trailer	\$9,825
---------------	-------------------------------------	----------------

- | | | | |
|---|--|--|--|
| <ul style="list-style-type: none"> • 500 Gallon Tank With Dished Ends • Two 3,500-lb Axles • Electric Brakes on One Axle • Tank Made of 10-ga. Steel With Baffle • 7,000-lb G.V.W.R. | <ul style="list-style-type: none"> • Fill-Rite 12V 20GPM Pump • Tires: 205-75R15 (or Equivalent) • Forged 2-5/16-in. Coupler • Safety Chains • Swivel Jack • Lockable Steel Battery/ | <ul style="list-style-type: none"> • Equipment Storage Box • Diamond Plate HD Fenders • Brake & Tail Lights • Equipped For Battery • 4-in. Channel Frame • Powder Coated Finish • Particle & Water Filter | <ul style="list-style-type: none"> • Fuel Gauge • Vented Filler Cap • 4 Placards Included • Dry Weight: 1060 lb • 146in L x 81in W x 70in H |
|---|--|--|--|

ADD-ON EQUIPMENT	PRICE
Hose Reel w/ 1-in. Plumbing & 25ft Hose for 20GPM Setup	\$1,389
Hose Reel w/ 1-in. Plumbing & 50ft Hose for 20GPM Setup	\$1,589
Hose Reel w/ 1-in. Plumbing & 25ft Hose for HVP Setup	\$1,399
Hose Reel w/ 1-in. Plumbing & 50ft Hose for HVP Setup	\$1,599

OPTIONAL EQUIPMENT	PRICE
Electric Brakes - (Both Axles) w/ Breakaway Switch	\$495
High Volume Gas-Powered Pump	\$1,295
Fill-Rite Mechanical Meter 901C With Plumbing Installed	\$485

LEE Equipment Catalog • 800-825-3346 • Sales@LeeAgra.com

Prices and specifications are subject to change without notice. FOB Lubbock, Texas. Prices effective December 16, 2022. LeeAgra, Inc • 117 E. 70th St. Lubbock, TX 79404



DT 975 Diesel Trailer

DT 975

Features

- Dished Flanged Ends
- Dual Baffle System
- Visible While Backing
- Tank Is Compatible For Use With Class 3 Combustible Materials
- Unit Is Manufactured For Farm Use



DT 975	1000-Gal. Diesel Fuel Trailer	\$13,925
---------------	--------------------------------------	-----------------

- | | | | |
|--|---|---|--|
| <ul style="list-style-type: none"> • 1000 Gallon Tank With Dished Ends • Two 6,000-lb Axles • Electric Brakes on One Axle • Tank Made of 3/16-in. Plate Steel With 2 Baffles • 12,000-lb G.V.W.R. | <ul style="list-style-type: none"> • Fill-Rite 12V 20GPM Pump • Tires: 235-80R16 (or Equivalent) • Forged 2-5/16-in. Coupler • Safety Chains • Swivel Jack • Diamond Plate HD Fenders | <ul style="list-style-type: none"> • Lockable Battery/Storage Box • Brake & Tail Lights • Equipped For Battery • 6-in. Channel Frame • Powder Coated Finish • Particle & Water Filter | <ul style="list-style-type: none"> • Fuel Gauge • Vented Filler Cap • 4 Placards Included • Dry Weight: 2565 lb • 172in L x 81in W x 88in H |
|--|---|---|--|

ADD-ON EQUIPMENT	PRICE
Hose Reel w/ 1-in. Plumbing & 25ft Hose for 20GPM Setup	\$1,389
Hose Reel w/ 1-in. Plumbing & 50ft Hose for 20GPM Setup	\$1,589
Hose Reel w/ 1-in. Plumbing & 25ft Hose for HVP Setup	\$1,399
Hose Reel w/ 1-in. Plumbing & 50ft Hose for HVP Setup	\$1,599

OPTIONAL EQUIPMENT	PRICE
Electric Brakes - (Both Axles) w/ Breakaway Switch	\$549
High Volume Gas-Powered Pump	\$1,295
Fill-Rite Mechanical Meter 901C With Plumbing Installed	\$485

LEE Equipment Catalog • 800-825-3346 • Sales@LeeAgra.com

Prices and specifications are subject to change without notice. FOB Lubbock, Texas. Prices effective December 16, 2022. LeeAgra, Inc • 117 E. 70th St. Lubbock, TX 79404



D.O.T. 500

Features

- Constructed To Meet D.O.T. Structural Requirements For Class 3 Combustible Materials
- Dished Flanged Ends
- Baffle System
- Visible While Backing



D.O.T. 500	500-Gal. Diesel Fuel Trailer	\$12,895
-------------------	-------------------------------------	-----------------

- | | | |
|---|---|---|
| <ul style="list-style-type: none"> • 500 Gallon Tank with Dished Ends • 7,000-lb G.V.W.R. • Two 3,500-lb Axles • Electric Brakes (2 Axles) & Breakaway Switch • Tank Made of 10-ga. Steel With Baffle • Fill-Rite 12V 20GPM Fuel Pump | <ul style="list-style-type: none"> • Trailer Frame Made Of Rectangular Tubing • Lockable Battery/Storage Box • Tires: 205-75R15 (or Equivalent) • Forged 2-5/16-in. Coupler • Powder Coated Finish • Particle & Water Filter • Safety Chains • Fuel Gauge | <ul style="list-style-type: none"> • Vented Filler Cap • Lighting • Swivel Jack • Diamond Plate HD Fenders • Equipped For Battery • 4 Placards Included • Dry Weight: 1878 lb • 150in L x 81in W x 77in H |
|---|---|---|

ADD-ON EQUIPMENT	PRICE
Hose Reel w/ 1-in. Plumbing & 25ft Hose for 20GPM Setup	\$1,389
Hose Reel w/ 1-in. Plumbing & 50ft Hose for 20GPM Setup	\$1,589

OPTIONAL EQUIPMENT	PRICE
Fill-Rite Mechanical Meter 901C With Plumbing Installed	\$485



D.O.T. 990

Features

- Constructed To Meet D.O.T. Structural Requirements For Class 3 Combustible Materials
- Dished Flanged Ends
- Baffle System
- Visible While Backing



D.O.T. 990	1000-Gal. Diesel Fuel Trailer	\$16,895
-------------------	--------------------------------------	-----------------

- | | | |
|--|--|--|
| <ul style="list-style-type: none"> • 1000 Gallon Tank With Dished Ends • 12,000-lb G.V.W.R. • Two 6,000-lb Axles • Electric Brakes (2 Axles) & Breakaway Switch • Tank Made of 3/16-in. Plate Steel with Baffle • Fill-Rite 12V 20GPM Pump | <ul style="list-style-type: none"> • Trailer Frame Made Of 6 in. Channel • Lockable Battery/Storage Box • Tires: 235-80R16 (or Equivalent) • Forged 2-5/16-in. Coupler • Powder Coated Finish • Particle & Water Filter • Safety Chains • Fuel Gauge | <ul style="list-style-type: none"> • Vented Filler Cap • Lighting • Swivel Jack • Diamond Plate HD Fenders • Equipped For Battery • 4 Placards Included • Dry Weight 3200 lb • 178in L x 85in W x 90in H |
|--|--|--|

ADD-ON EQUIPMENT	PRICE
Hose Reel w/ 1-in. Plumbing & 25ft Hose for 20GPM Setup	\$1,389
Hose Reel w/ 1-in. Plumbing & 50ft Hose for 20GPM Setup	\$1,589

OPTIONAL EQUIPMENT	PRICE
Fill-Rite Mechanical Meter 901C With Plumbing Installed	\$485



DT 100 Portable Tank

DT 100

Our superior quality tank is now available in the smallest form factor.

Features

- Vented Fuel Cap
- Liquid Level
- 10 Ga. Steel
- Standard 2in. NPT
- 2in. drain port.
- Powder Coating
- Forklift rails
- Fits on a pallet

Dimensions

- Length 23.75in.
- Width 38in.
- Height 41.25in.

Specs

- Capacity: 100 gal
- Dry weight: 190lb
- Loaded Weight: 945lb



MODEL	DESCRIPTION	<i>*Dealer Discounts Do Not Apply</i>	BASE PRICE
LA-T1A000	DT 100 Portable Fuel Tank. Includes vented fuel cap and gauge only.		\$1225
LA-T1A300	DT 100 w/Installed Fill-Rite 13gpm pump, manual nozzle, fuel filter, HD siphon tube.		\$1775
LA-T1A500	DT 100 w/Installed Fill-Rite hand pump, manual nozzle, fuel filter, HD siphon tube.		\$1600

LEE Equipment Catalog • 800-825-3346 • Sales@LeeAgra.com

Prices and specifications are subject to change without notice. FOB Lubbock, Texas. Prices effective December 16, 2022. LeeAgra, Inc • 117 E. 70th St. Lubbock, TX 79404



DT 200 Portable Tank

DT 200

Our superior quality tank is now available in a size perfect for the smaller fuel requirements.

Features

- Vented Fuel Cap
- Liquid Level
- 10 Ga. Steel
- Standard 2in. NPT
- 2in. drain port.
- Powder Coating
- Forklift rails
- Fits on a pallet

Dimensions

- Length 47.25in.
- Width 38in.
- Height 41.25in.

Specs

- Capacity: 200 gal
- Dry weight: 380lb
- Loaded Weight: 1890lb



Plumb 5 together for 1000 gallons of portable fuel storage!



MODEL	DESCRIPTION	*Dealer Discounts Do Not Apply	BASE PRICE
LA-D2A000	DT 200 Portable Fuel Tank. Includes vented fuel cap and gauge only.		\$1495

LEE Equipment Catalog • 800-825-3346 • Sales@LeeAgra.com

Prices and specifications are subject to change without notice. FOB Lubbock, Texas. Prices effective December 16, 2022. LeeAgra, Inc • 117 E. 70th St. Lubbock, TX 79404



DT 200 w/ Fill-Rite 13GPM Pump

DT 200

Fuel Pump

- 13GPM
- 12 volt
- 12ft. 3/4in. Hose
- Manual Nozzle
- Battery Clamps

Features

- Vented Fuel Cap
- Liquid Level
- 10 Ga. Steel
- Standard 2in. NPT
- 2in. drain port.
- Powder Coating
- Forklift rails
- Fits on a pallet

Dimensions

- Length 47.25in.
- Width 38in.
- Height 56in.

Specs

- Capacity: 200 gal
- Dry weight: 380lb
- Loaded Weight: 1890lb



FILL-RITE 13GPM 12V Pump installed on the LEE DT 200.

MODEL	DESCRIPTION	*Dealer Discounts Do Not Apply	BASE PRICE
LA-D2A300	DT 200 w/Installed Fill-Rite 13gpm pump, manual nozzle, fuel filter, HD siphon tube.		\$1975

LEE Equipment Catalog • 800-825-3346 • Sales@LeeAgra.com

Prices and specifications are subject to change without notice. FOB Lubbock, Texas. Prices effective December 16, 2022. LeeAgra, Inc • 117 E. 70th St. Lubbock, TX 79404



DT 200 w/ Fill-Rite 20GPM Pump

DT 200

Fuel Pump

- 20GPM
- 12 volt
- 12ft. 1in. Hose
- Auto Nozzle
- Battery Clamps

Features

- Vented Fuel Cap
- Liquid Level
- 10 Ga. Steel
- Standard 2in. NPT
- 2in. drain port.
- Powder Coating
- Forklift rails
- Fits on a pallet

Dimensions

- Length 47.25in.
- Width 38in.
- Height 56in.

Specs

- Capacity: 200 gal
- Dry weight: 380lb
- Loaded Weight: 1890lb



FILL-RITE® 20GPM 12V Pump installed on the LEE DT 200.

MODEL	DESCRIPTION	*Dealer Discounts Do Not Apply	BASE PRICE
LA-D2A100	DT 200 w/Installed Fill-Rite 20GPM pump, automatic nozzle, fuel filter, HD siphon tube.		\$2125

LEE Equipment Catalog • 800-825-3346 • Sales@LeeAgra.com

Prices and specifications are subject to change without notice. FOB Lubbock, Texas. Prices effective December 16, 2022. LeeAgra, Inc • 117 E. 70th St. Lubbock, TX 79404



DT 200 w/ Fill-Rite Hand Pump

DT 200

Fuel Pump

- 20GP/100 Strokes
- Reversible flow
- 8ft. 3/4in. Hose
- 3/4in. Hose End Spout

Features

- Vented Fuel Cap
- Liquid Level
- 10 Ga. Steel
- Standard 2in. NPT
- 2in. drain port.
- Powder Coating
- Forklift rails
- Fits on a pallet

Dimensions

- Length 47.25in.
- Width 38in.
- Height 56in.

Specs

- Capacity: 200 gal
- Dry weight: 380lb
- Loaded Weight: 1890lb



FILL-RITE
Hand Pump installed
on the LEE DT 200.

MODEL	DESCRIPTION	*Dealer Discounts Do Not Apply	BASE PRICE
LA-D2A500	DT 200 w/Installed Fill-Rite hand pump, manual nozzle, fuel filter, HD siphon tube.		\$1875

LEE Equipment Catalog • 800-825-3346 • Sales@LeeAgra.com

Prices and specifications are subject to change without notice. FOB Lubbock, Texas. Prices effective December 16, 2022. LeeAgra, Inc • 117 E. 70th St. Lubbock, TX 79404



DT 2x100 Portable Tank

DT 2x100

Each tank has:

- 2in. fill opening with cap
- 2in. opening
- 2in. bottom drain
- 2 fuel gauges

Features

- 10 Ga. Steel
- Standard 2in. NPT
- 2in. drain port.
- Powder Coating
- Forklift rails
- Fits on a pallet

Dimensions

- Length 47.25in.
- Width 38in.
- Height 41.25in.

Specs

- Capacity: 200 gal
- Dry weight: 380lb
- Loaded Weight: 1890lb



Cutaway View

Two 100 gallon tanks completely divided for storing separate materials.

Supports two NPT pumps.

MODEL	DESCRIPTION	*Dealer Discounts Do Not Apply	BASE PRICE
LA-D1A000	DT 2x100 Portable Fuel Tank. Includes 2 vented fuel caps and 2 gauges.		\$2095

LEE Equipment Catalog • 800-825-3346 • Sales@LeeAgra.com

Prices and specifications are subject to change without notice. FOB Lubbock, Texas. Prices effective December 16, 2022. LeeAgra, Inc • 117 E. 70th St. Lubbock, TX 79404



DT 200 Cart

200 Gallon Tank Cart



LA-DT200CART

Move your 200 gallon tank short distances with ease!

Works with:



DT 200



DT 2x100



DT 100

- Tank sold separately.
- Assembly required for cart package.

Caution! Cart is designed for short distance use only. The cart does not have spring suspension, is not designed day to day road use hauling fuel.

***Dealer Discounts Do Not Apply**

MODEL	DESCRIPTION	BASE PRICE
LA-DT200CART	Cart for 200 Gallon Tank.	\$675
522065	DT 100 Tank mounting bracket. *needed to mount one DT 100	Free

LEE Equipment Catalog • 800-825-3346 • Sales@LeeAgra.com

Prices and specifications are subject to change without notice. FOB Lubbock, Texas. Prices effective December 16, 2022. LeeAgra, Inc • 117 E. 70th St. Lubbock, TX 79404



DT 200 Trailer

200 Gallon Trailer



Take your diesel fuel tanks on the highway!

Perfect for:

DT 200* *DT 2x100

DT 100

(sold separately)

Features

- Highway Use
- Diamond Plate Fenders
- Trailer Lights
- 1000lb. Jack
- Powder Coating
- Foldable Tongue

Specs

- Axle Type: Spring Suspension
- Tires: 205-75R15 (or equivalent)
- Channel Frame
- 2in. Coupler
- 3,500lb. G.V.W.R.

MODEL	DESCRIPTION	*Dealer Discounts Do Not Apply	BASE PRICE
LA-XP522040	200 Gallon Trailer. <i>\$100 pallet fee on every shipped DT 200 Trailer.</i>		\$1695

LEE Equipment Catalog • 800-825-3346 • Sales@LeeAgra.com

Prices and specifications are subject to change without notice. FOB Lubbock, Texas. Prices effective December 16, 2022. LeeAgra, Inc • 117 E. 70th St. Lubbock, TX 79404



DT 500 Portable Tank

DT 500



Easily store and dispense 500 gallons of diesel fuel!

Features

- Vented Fuel Cap
- Liquid Level
- 10 Ga. Steel
- Standard 2in. NPT
- 2in. drain port.
- Powder Coating
- D-Rings for movement

Dimensions

- Length 72in.
- Width 52in.
- Height 50in.

Specs

- Capacity: 500 gal
- Dry weight: 750lb
- Loaded Weight: 4750lb

MODEL	DESCRIPTION	*Dealer Discounts Do Not Apply	BASE PRICE
LA-D2A500	DT 500 five-hundred gallon diesel-fuel tank. Pump sold separately. \$100 pallet fee.		\$2695

LEE Equipment Catalog • 800-825-3346 • Sales@LeeAgra.com

Prices and specifications are subject to change without notice. FOB Lubbock, Texas. Prices effective December 16, 2022. LeeAgra, Inc • 117 E. 70th St. Lubbock, TX 79404

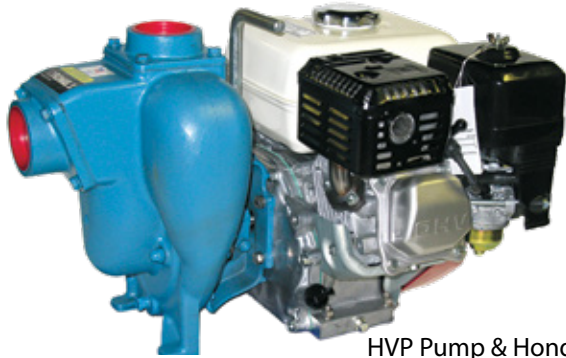

HVP Pump & Honda Engine
230216



25ft Hose Reel
230135
50ft Hose Reel
230130



HD Siphon Tube
420176 42in.
420177 52.5
422060 36in.



Fuel Hose MPT 1in.
320167



Filter Head Adaptor
230248



DT Liquid Level
230141
230142
230143



Battery Cable Black
230434



DT Fuel Filter
230026



Plug MPT 2in. Blk
150022

PART #	DESCRIPTION	PRICE
420176	HD Siphon Tube 42in. DT 475 / D.O.T. 500	\$49
420177	HD Siphon Tube 52.5in. DT 975 / D.O.T. 990	\$45
422060	HD Siphon Tube 36in. Heavy Duty Siphon Tube DT 200 / DT 2x100	\$39
520112	High Volume Gas-Powered Pump. Engine and pump only.	\$1,295
520106	High Volume Gas-Powered Pump Kit. Engine, pump, hoses, and plumbing.	\$1,850
230135	Hose Reel w/ 25ft hose.	\$1,149
230130	Hose Reel w/ 50ft hose.	\$1,249
520140	Hose Reel w/ 25ft. hose, brackets, fasteners and fittings.	\$1,389
520141	Hose Reel w/ 50ft. hose, brackets, fasteners and fittings.	\$1,589
230026	DT Fuel Filter. Spin on. 10 Micron. 25 GPM.	\$18
230248	Fuel Filter Head Adapter 1in. Single.	\$70
320167	Fuel Transfer Hose MPT 1in. By the foot.	\$5.25/ft.
230434	Battery Cable. Black. By the foot.	\$1.95/ft.
230141	DT Fill Gauge 500gal. Liquid level gauge for 43in. tank. New style.	\$59
230142	DT Fill Gauge 1000gal. Liquid level gauge for 54in. tank New style.	\$69
230143	DT Fill Gauge 200gal. Liquid level gauge for 35in. tank New style.	\$55
230131	DT Fill Gauge 500/1000gal. OS Liquid level gauge for 43in. and 54 in. tank. Old style.	\$129
150022	Plug MPT 2in. Black. Cast iron.	\$5



120144



220039



220053



220031



220052



250120



120037



120038



120097



120032



120033



260308



250104



250025



250025



250057



510030



280085



250208



220322



250835



250836

PART #	DESCRIPTION	PRICE
120144	License Plate Light.	\$3.79
220039	LED I.D. Light.	\$29
220053	Oval Light 6in.	\$16
220031	Clearance Light Kit 2in. Amber.	\$9
220052	Clearance Light Kit 2in. Red.	\$9
250120	Safety Chain. Two required per trailer. Price per chain.	\$15
250007	Safety Chain 1/4x61in. DT 200	\$12
120038	Fuse Holder 30amp.	\$2.50
120037	Fuse Holder Cover. Clear.	\$1.59
120097	Trailer End Connector 7-Pin. Male plug.	\$12
120032	Battery Clamp Black. 200amp Black.	\$6.79
120033	Battery Clamp Red. 200amp Red.	\$6.79
260308	Wiring Harness 7 Strand. 475-975 wire harness w/7 pin PLUG 7 strand	\$165
250104	Coupler 2-5/16in. 2 5/16in. coupler only. Heavy duty for 3 POS channel.	\$109
250025	Pintle Hitch 14K. Pintle Hitch 14K	\$59
250054	Jack Side Wind 5K. Swivel 15 bulldog.	\$95
250057	Jack Bolt Mount 2K. DT 200 Cart.	\$49
510030	HD Battery Toolbox 28in. Black.	\$185
280085	Breakaway Kit w/ Charger.	\$55
250208	Battery Box Hold Down Kit. Plastic.	\$9
220322	Battery Tender 12V 1.25amp. 12V 1.25amp	\$55
250835	Tire and Wheel 205/75R15. 5-Hole Black Mod. DT 475 / D.O.T. 500 / DT 200 Cart	\$185
250836	Tire and Wheel LT235-80R16. 8-Hole Black Mod. DT 975 / D.O.T. 990	\$235



DT 200 LEE Installed Options

ITEM#	DESCRIPTION	<i>*Dealer Discounts Do Not Apply</i>	PRICE
LA-S100H1315	Hose Swivel 1in. Installed		\$69
LA-S075H1314	Hose Swivel 3/4in. Installed		\$59
LA-901C	Fuel Meter Mechanical 901C Installed		\$289
LA-XPDFLOW1	Fuel Meter Digital Inline Installed		\$335
DT Hose Reel	Hose Reel 25ft. Installed		\$1389
DT Hose Reel	Hose Reel 50ft. Installed		\$1589
LA-XP422089	Hose Tray up to 75ft. Capacity		\$75
LA-XP522084	DT 200 Hose Reel Mounting Kit		\$54
LA-XP522082	DT 200 Platform Mount. Two can be installed. Each.		\$114
LA-XP522087	DT 200 HD Battery Box		\$289
LA-XP522081	DT 200 Tank Riser		\$89
LA-XP522030	DT2x100 Tandem Tank Plumbing		\$295
LA-XP522025	DT 200 Mounting Skid for DT 475 Trailer		\$389
LA-XP522088	Vent 2in.		\$59
320167	Hose by the foot Installed 1in.		\$5.25/ft.
250554	Hose by the foot Installed 3/4in.		\$4.25/ft.
LA-XP522085	Pump Enclosure Cabinet (Coming Soon)		
LA-XP522086	DT 200 Containment Tray (Coming Soon)		



DT 200 Customer Installed Kits

ITEM#	DESCRIPTION	<i>*Dealer Discounts Do Not Apply</i>	PRICE
LA-SD1202G	Fill-Rite 12V 13gpm Pump Kit (No filter package or siphon tube)		\$475
LA-FR1210G	Fill-Rite 12V 15gpm Pump Kit (No filter package or siphon tube)		\$445
LA-FR4210G	Fill-Rite 12V 20gpm Pump Kit (No filter package or siphon tube)		\$535
LA-FR610G	Fill-Rite 115V 15gpm Pump Kit (No filter package or siphon tube)		\$565
LA-FR700V	Fill-Rite 115V 20gpm Pump Kit (No filter package or siphon tube)		\$745
LA-FR152	Fill-Rite Piston Hand Pump Kit (No filter package or siphon tube)		\$245
LA-422060	DT 200 Heavy Duty Siphon Tube		\$39
LA-XP520250	Filter Kit for 3/4in. pump package		\$105
LA-XP520251	Filter Kit for 1in. pump package		\$95
LA-XP422089	DT 200 Hose Tray up to 75ft. Capacity		\$75
LA-XP522084	DT 200 Hose Reel Plate Kit		\$36
LA-XP522082	DT 200 Platform Mount. Two can be installed. Each.		\$114
LA-XP522087	DT 200 HD Battery Box		\$289
LA-XP522081	DT 200 Tank Riser		\$65
LA-XP522085	Pump Enclosure Cabinet (Coming Soon)		
LA-XP522086	DT 200 Containment Tray (Coming Soon)		



DT 200 Replacement Parts

ITEM#	DESCRIPTION	<i>*Dealer Discounts Do Not Apply</i>	PRICE
230143	Liquid level gauge for 200gal. 35in. tank (replacement assembly)		\$55
120032	Battery Clamp Black		\$6.75
120033	Battery Clamp Red		\$6.75
230149	Krueger Fuel Gauge Sight Glass Replacement		\$12.50
230026	Spin on filter for diesel fuel, 10 micron, 25 GPM		\$18
230248	Fuel Filter Head Adapter 1in. Single.		\$70

FILL-RITE.



LA-FR4204G



LA-SD1202G



LA-NX25-DDCNB-PX



LA-FR152



LA-901C



LA-FRH10012



LA-FRTCB



LA-N100DAU12G



LA-FRHMN075S



LA-S100H1315



LA-S075H1314

PART #	ITEM	DESCRIPTION	<i>*Dealer Discounts Do Not Apply</i>	PRICE
LA-FR4204G	20GPM Pump Only	Fill-Rite pump only. 12V 20GPM 1in.		\$445
LA-SD1202G	13GPM Pump Kit	Fill-Rite pump with telescoping tube, hose, and nozzle.		\$475
LA-NX25-DDCNB-PX	25GPM Pump Only	Fill-Rite continuous duty pump only. 12V 25GPM. 1in.		N/A
LA-FR152	Piston Hand Pump	Fill-Rite pump with telescoping tube, hose, and nozzle.		\$245
LA-901C	4-Wheel Mechanical Meter	Fill-Rite 4-wheel mechanical meter, 1in., 6-40GPM		\$365
LA-FRH10012	Fuel Transfer Hose 1in. 12ft	Fill-Rite Fuel Transfer Hose 1in. x 12ft.		\$95
LA-FRTCB	Tank Vent Cap 2in.	Fill-Rite tank vent cap with base. 2in.		\$45
LA-N100DAU12G	Auto Nozzle 1in.	Fill-Rite 1in. automatic nozzle with hook. Green.		\$155
LA-FRHMN075S	Fuel Nozzle 3/4in. Manual	Fill-Rite UL manual nozzle with hook. 3/4in. FPT		\$45
LA-S100H1315	Multi-Plane Swivel 1in.	Fill-Rite aluminum swivel w/ 360 deg. rotation. 1in.		\$85
LA-S075H1314	Multi-Plane Swivel 3/4in.	Fill-Rite aluminum swivel w/ 360 deg. rotation. 3/4in.		\$55

WE ASSEMBLE. YOU INSTALL.



LA-PKFR20GPM

- Turn-key pump solution
- 20GPM Diesel Fuel Pump

LA-PKFR25GPM

- Turn-key pump solution
- 25GPM Diesel Fuel Pump
Continuous Duty

Assembly includes the following components:



PART #	ITEM	DESCRIPTION	<i>*Dealer Discounts Do Not Apply</i>	PRICE
LA-PKFR20GPM	20GPM Pump Kit	Fill-Rite pump plus nozzle, cable, hose.		\$625
LA-PKFR25GPM	25GPM Pump Kit	Fill-Rite pump plus nozzle, cable, hose		N/A

LoadSABER LS2



- Compact heavy-duty construction
- Easy one person setup
- Utilizes your tractors rear lift
- Tilt-Lock Chain for stability

LEE LoadSABER

**Easily attaches to
Cat-2 and Cat-3
quick hitches.**

Quick
hitch sold
separately.



PART #	ITEM	DESCRIPTION	PRICE
LA-LS2	LoadSABER package for Cat2+3	Two boots and two spears for Cat-2 and 3.	\$475
LA-LS2-B	LoadSABER boots for Cat2+3	Two boots for Cat-2 and above.	\$375
250001	Hay Bale Spear	Replacement Spear for LoadSABER.	\$66



LEE Equipment Catalog • 800-825-3346 • Sales@LeeAgra.com

Prices and specifications are subject to change without notice. FOB Lubbock, Texas. Prices effective December 16, 2022. LeeAgra, Inc • 117 E. 70th St. Lubbock, TX 79404

LoadSABER LS1

GIVE YOUR TRACTOR A LIFT!



- Adds lifting to any category 1 tractor
- Compact heavy-duty construction
- Easy one person setup
- Easily attaches to Cat-1 quick hitch
- Utilizes your tractors rear lift

PART #	ITEM	DESCRIPTION	PRICE
LA-LS1	LoadSABER package for Cat1	Two boots and two spears for Cat-1.	\$375
LA-LS1-B	LoadSABER boots for Cat1	Two boots for Cat-1.	\$275
250001	Hay Bale Spear	Replacement Spear for LoadSABER.	\$66



LEE Equipment Catalog • 800-825-3346 • Sales@LeeAgra.com

Prices and specifications are subject to change without notice. FOB Lubbock, Texas. Prices effective December 16, 2022. LeeAgra, Inc. • 117 E. 70th St. Lubbock, TX 79404



STACK 'EM UP!



**FREE DISPLAY RACK
with an order of
8 Pair of LoadSABERs!
LS1 or LS2 models**

MODEL	DESCRIPTION	PRICE
540010	LoadSABER Rack	\$399

LEE Equipment Catalog • 800-825-3346 • Sales@LeeAgra.com

Prices and specifications are subject to change without notice. FOB Lubbock, Texas. Prices effective December 16, 2022. LeeAgra, Inc • 117 E. 70th St. Lubbock, TX 79404



BOSS Quick Hitch

IT'S CALLED THE

BOSS

by LEE

FOR A REASON.

IT'S THE TOUGHEST THREE-POINT HITCH IN THE WORLD. PERIOD.



BOSS Features

- Heavy Duty Steel Construction
- Heat Treated Boss Fittings
- Powder Coating
- T1 Precision Cut Hooks
- CNC Machined Pins
- Quick Release Handles
- Cat-2, 3, & 4 Tractor & Implement Sizes

LEE Equipment Catalog • 800-825-3346 • Sales@LeeAgra.com

Prices and specifications are subject to change without notice. FOB Lubbock, Texas. Prices effective December 16, 2022. LeeAgra, Inc • 117 E. 70th St. Lubbock, TX 79404

BOSS Cat-4

MODEL	TRACTOR	IMPLEMENT	PINS	WEIGHT	PRICE
LA-QHC4	Cat-4	Cat-4	Cat-4	298 lb	\$4,485
LA-QHC4N3	Cat-3W & 4H	Cat-3W & 4H	Cat-3	281 lb	\$4,285
LA-QHC4N4	Cat-3W & 4H	Cat-3W & 4H	Cat-4	281 lb	\$4,285

This BOSS is a hoss. The only thing tougher than a Cat-3 BOSS is a Cat-4 BOSS. Quit worrying about that cast iron OEM cat-4 giving way. Put the BOSS to work for you.



BOSS Cat-3-2 Combo

MODEL	TRACTOR	IMPLEMENT	PINS	WEIGHT	PRICE
LA-QHC3C33	Cat-2 & 3	Cat-3	Cat-3	225 lb	\$1,689
LA-QHC3C32	Cat-2 & 3	Cat-3	Cat-2	225 lb	\$1,689

It's the best three-point hitch on the market that is a Cat-3 hitch that fits a Cat-2 or Cat-3 tractor to lift Cat-3 equipment. It's like having two hitches for the price of one!

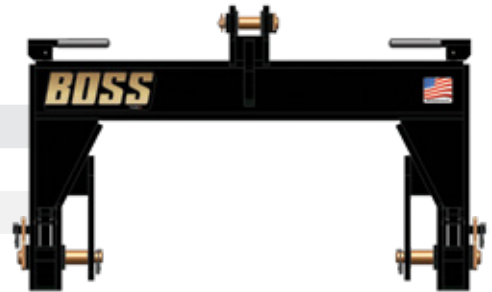

BOSS Cat-3

MODEL	TRACTOR	IMPLEMENT	PINS	WEIGHT	PRICE
LA-QHC3	Cat-3	Cat-3	Cat-3	215 lb	\$1,489

Tractor manufacturers sometimes make their own hitches. Don't settle with a cast iron OEM hitch! Demand a BOSS three-point hitch that'll outlast your tractor!

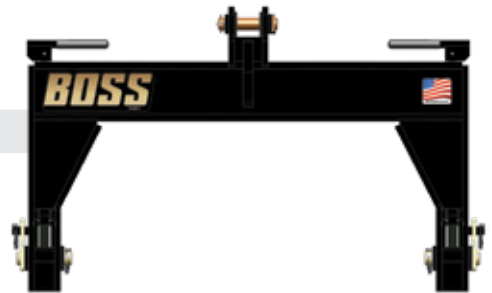

BOSS Cat-3N

MODEL	TRACTOR	IMPLEMENT	PINS	WEIGHT	PRICE
LA-QHC3N3	Cat-2W & 3H	Cat-2W & 3H	Cat-3	201 lb	\$1,489
LA-QHC3N2	Cat-2W & 3H	Cat-2W & 3H	Cat-2	201 lb	\$1,489

The BOSS Cat-3N is as tall as the Cat-3 but as wide as the Cat-2. This narrow hitch is perfect for carrying heavier implements on your narrow setup.

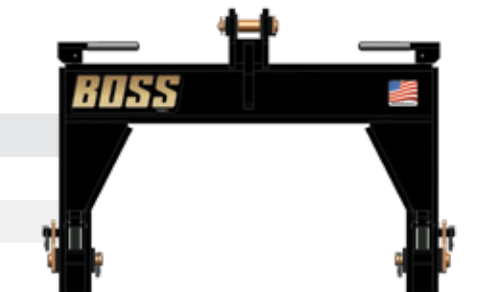

BOSS Cat-2

MODEL	TRACTOR	IMPLEMENT	PINS	WEIGHT	PRICE
LA-QHC2C23	Cat-2	Cat-2	Cat-3	200 lb	\$1,245
LA-QHC2C22	Cat-2	Cat-2	Cat-2	200 lb	\$1,245

Take the headache out of connecting your Cat-2 implements to your Cat-2 tractor. Quickly and safely connect and disconnect your tools with ease.

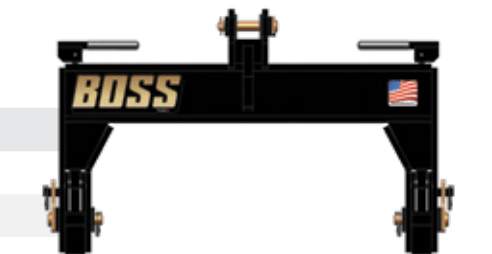

PLANT ON 20 INCH ROW SPACING WITH 40 INCH ROW EQUIPMENT.



With this Side Swipe Boss Hitch, a grower can use his existing equipment to plant and possibly work in tight row spacings.

MODEL	DESCRIPTION	PRICE
LA-QHC3SS	BOSS Cat-3 Sideswipe Quick Hitch *SPECIAL ORDER*	\$2995

LEE Equipment Catalog • 800-825-3346 • Sales@LeeAgra.com

Prices and specifications are subject to change without notice. FOB Lubbock, Texas. Prices effective December 16, 2022. LeeAgra, Inc • 117 E. 70th St. Lubbock, TX 79404



BOSS Quick Hitch Rack

Order 4 BOSS Quick Hitches and you'll get the display FREE!
A \$495 value!

Elevated display design uses minimal floor space.

Safely display hitches by keeping the product orderly.

Accommodates all Lee hitches including the exclusive BOSS Combo Hitch!

MODEL	DESCRIPTION	PRICE
LA-QHRACK	BOSS Quick Hitch Rack	\$495

LEE Equipment Catalog • 800-825-3346 • Sales@LeeAgra.com

Prices and specifications are subject to change without notice. FOB Lubbock, Texas. Prices effective December 16, 2022. LeeAgra, Inc • 117 E. 70th St. Lubbock, TX 79404



Quick Hitch Dimensions

The following dimensions are industry wide specifications. The Lee Quick Hitches are designed to have slight dimensional alterations. This change is made to allow for a more versatile field application, resulting in easier mounting and dismounting of implements. Note: The C3C32 or C3C33 combination hitch can be used with any category 2 or 3 tractors. The implement side of the hitch will always be category 3.

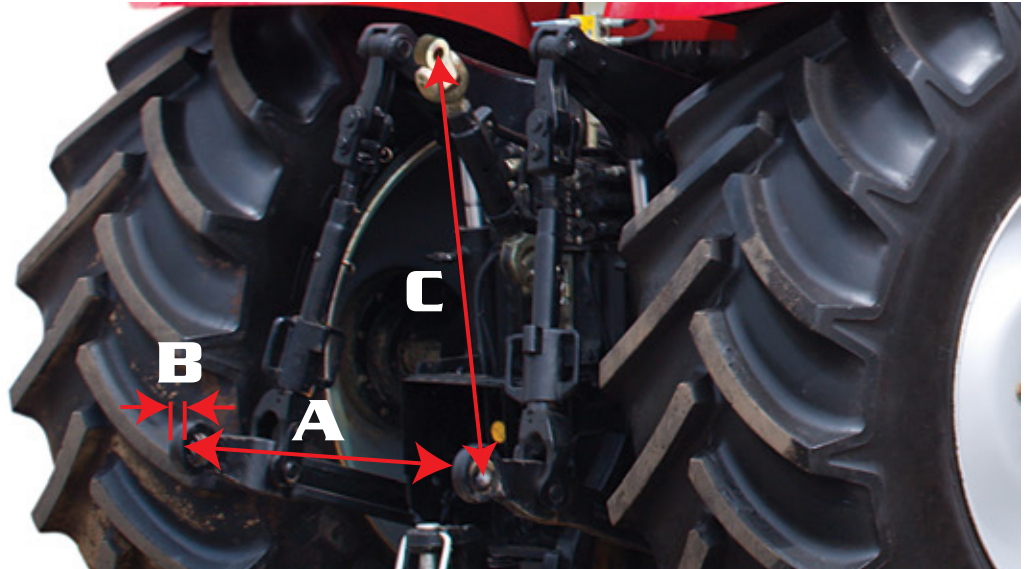

	Category 1		Category 2		Category 3N		Category 3		Category 4N		Category 4	
Upper Link PIN Diameter	.75 in.	19mm	1 in.	25.4mm	1.25 in.	31.75mm	1.25 in.	31.75mm	1.77 in.	44.96mm	1.77 in.	44.96mm
Upper Link HOLE Diameter	.76 in.	19.3mm	1.01 in.	25.65mm	1.26 in.	32mm	1.26 in.	32mm	1.78 in.	45.21mm	1.78 in.	45.21mm
Lower Link PIN Diameter	.88 in.	22.22mm	1.10 in.	27.94mm	1.44 in.	36.58mm	1.44 in.	36.58mm	2 in.	50.8mm	2 in.	50.8mm
Lower Link HOLE Diameter	.88 in.	22.4mm	1.13 in.	28.70mm	1.47 in.	37.34mm	1.47 in.	37.34mm	2.01 in.	51.05mm	2.01 in.	51.05mm
Lower Hitch Point Span (A)	15.79 in.	401mm	32.48 in.	825mm	32.48 in.	825mm	37.99 in.	964.95mm	36.22 in.	920mm	45.93 in.	1166.62mm
Width of Ball (B)	1.38 in.	35mm	1.77 in.	44.96mm	1.77 in.	44.96mm	1.77 in.	44.96mm	2.26 in.	57.4mm	2.26 in.	57.4mm
Pin Centerline - Lower to Upper (C)	14.17 in.	360mm	24.02 in.	610.11mm	26.97 in.	685.04mm	26.97 in.	685.04mm	26.97 in.	685.04mm	26.97 in.	685.04mm

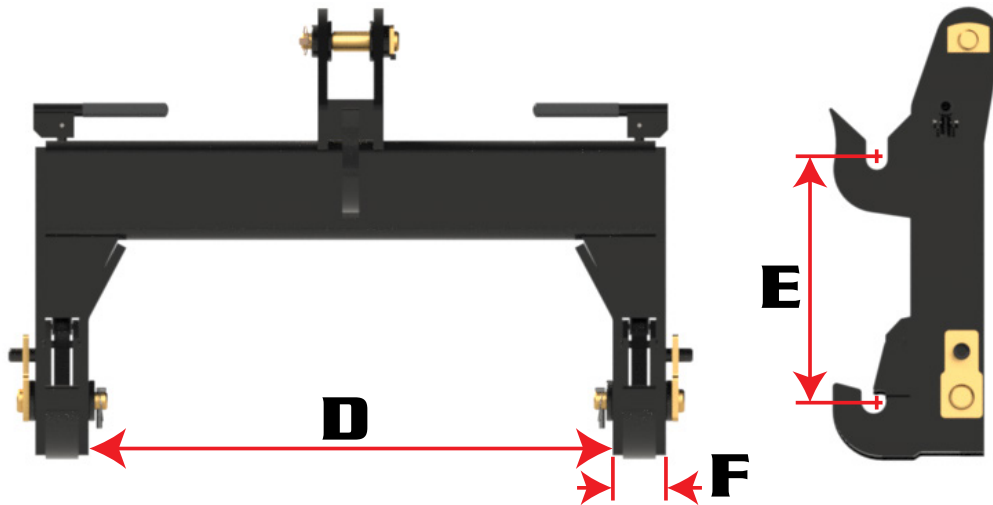

	Lower Hitch Point Span (D)		Pin Centerline Lower To Upper (E)		Width Of Hook (F)	
	MIN	MAX	MIN	MAX		
Category 1	27.4 in. 695.96mm	27.64 in. 702.06mm	16 in. 406.4mm	21 in. 533.4mm	1.5 in.	38.1mm
Category 2	32.62 in. 828.55mm	32.84 in. 834.14mm	14.78 in. 375.41mm	14.88 in. 377.95mm	2 in.	50.80mm
Category 3N	32.62 in. 828.55mm	32.84 in. 834.14mm	18.78 in. 477 mm	18.88 in. 479.55mm	2 in.	50.80mm
Category 3	38.18 in. 969.77mm	38.40 in. 975.36mm	18.78 in. 477mm	18.88 in. 479.55mm	2 in.	50.80mm
Category 4N	38.10 in. 967.74 mm	38.40 in. 975.36 mm	26.77 in. 679.96 mm	26.89 in. 683 mm	2 in.	50.80mm
Category 4	46.10 in. 1170.94 mm	46.22 in. 1174 mm	26.77 in. 679.96 mm	26.89 in. 683 mm	2 in.	50.80mm

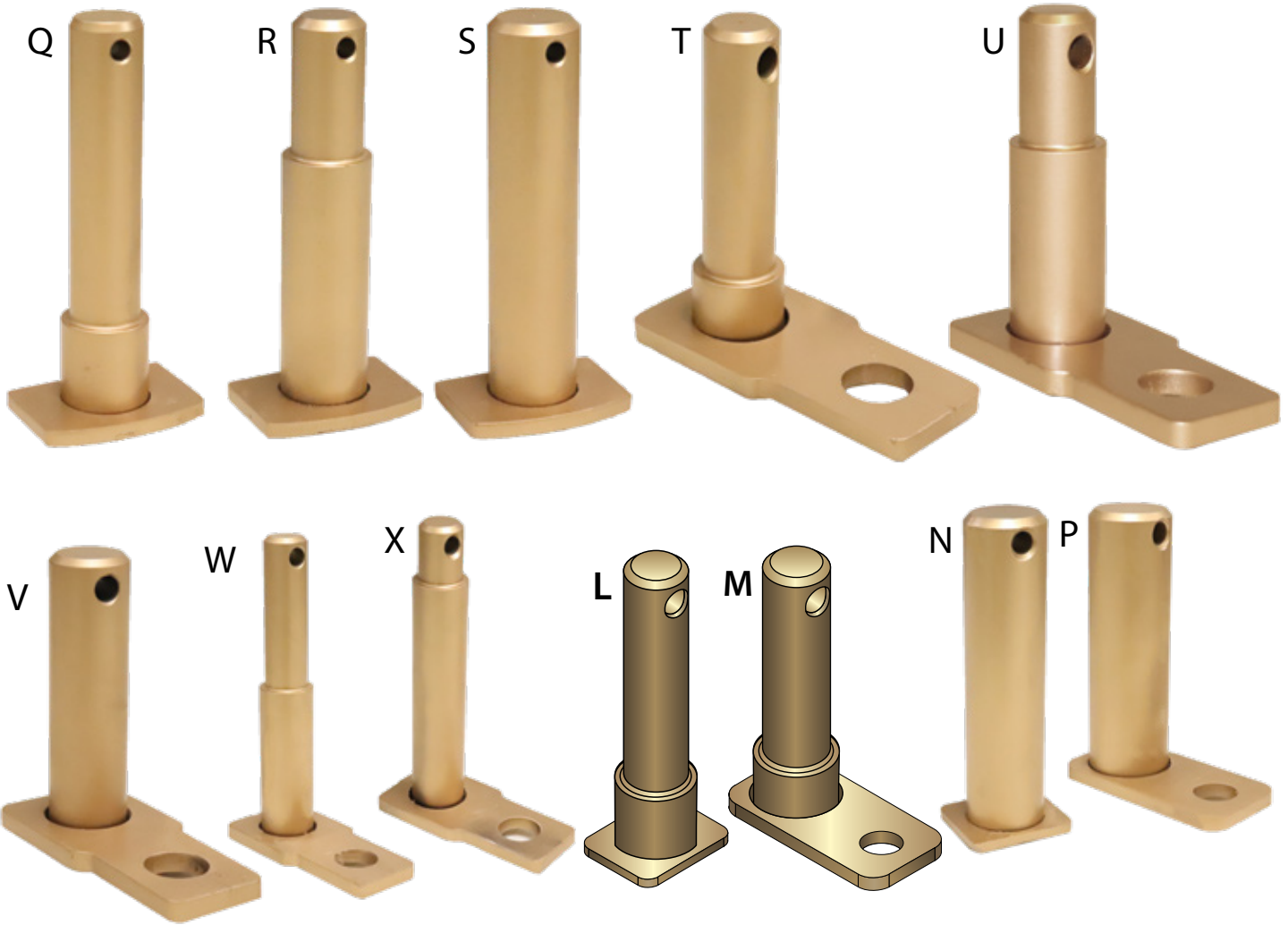

New #	Old #	Ref.	Quick Hitch Ref.	PRICE
530004	80026	Q	C2C22A, C3N2A, C3C32A	\$47
530013	80025	R	C2C23A, C3N3A, C3C33A	\$46
530002	80023	S	C3A	\$42
530007	80029	T	C2C22A,C3N2A	\$54
530003	80024	U	C2C23A,C3N3A	\$51
530001	80022	V	C3A	\$46
530006	80028	W	C3C32A	\$59
530005	80027	X	C3C33A	\$55
530045		L	C4N3 Top Pin	\$79
530047		M	C4N3 Bottom Pin	\$84
530044		N	C4, C4N4 Top Pin	\$53
530046		P	C4, C4N4 Bottom Pin	\$70



BOSS 3-Point Hitch Pin Kits

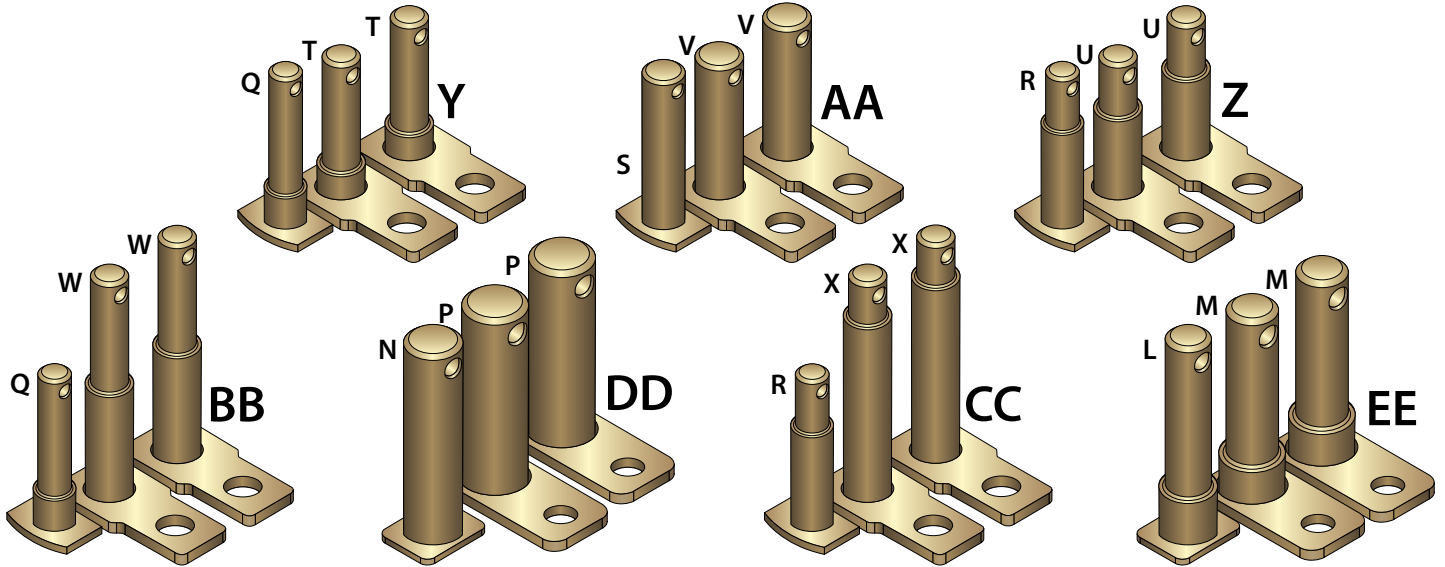

New #	Old #	Ref.	Quick Hitch Ref.	PRICE
430004	80101	Y	C2C22A, C3N2A	\$144
430005	80102	Z	C2C23A, C3N3A	\$143
430014	80103	AA	C3A	\$119
430006	80104	BB	C3C32A	\$154
430007	80102	CC	C3C33A	\$154
530048		DD	C4, C4N4	\$215
530049		EE	C4N3	\$179



Battery Boxes



PART #	ITEM	DESCRIPTION	Weight	PRICE
LA-BB28X8	Battery Box 28 in.	28in. L x 8in. W x 10in. T	42.5 lb	\$359
LA-BB45X10	Battery Box 45 in.	45in. L x 10in. W x 11.5in. T	74 lb	\$419
LA-BB45X12	Battery Box 45 in.	45in. L x 12in. W x 11.5in. T	81.5 lb	\$419
LA-BB45X16	Battery Box 45 in.	45in. L x 16in. W x 11.5in. T	87 lb	\$429
LA-BB45X16AL	Battery Box 45 in. Alum.	45in. L x 16in. W x 11.5in. T Aluminum.	31 lb	\$489
501001	242 Gallon Diesel Tank Gen. Set		545 lb	\$1,819



PART #	ITEM	DESCRIPTION	SIZE	PRICE
200007	Class 3 Combustible Placard	UV Coated.	15.25in. W x 15.25in. H	\$8
200009	Made in the USA	UV Coated.	2.25in. W x 1in. H	\$4
200010	DT 200	UV Coated.	14in. W x 3in. H	\$11
200076	DT 475	UV Coated.	13.8in. W x 3in. H	\$11
200077	DT 975	UV Coated.	13.8in. W x 3in. H	\$11
200085	LEE Decal Universal	UV Coated.	9.6in. W x 3.2in. H	\$8
200099	DT 2x100	UV Coated.	17.6in. W x 3in. H	\$11
200122	D.O.T. 500	UV Coated.	18in. W x 3.3in. H	\$12
220203	Lee Spider	UV Coated.	7.5in. W x 3.3in. H	\$9
200204	D.O.T. 990	UV Coated.	18in. W x 3.3in. H	\$12



****Dealer Discounts Do Not Apply***

PART #	ITEM	DESCRIPTION	TEXT	Size	PRICE
LA-GRCAP603439	LeeAgra Ball Cap	Mesh back. Black/White.	LEEAGRA Quality Equipment 1949	L	\$27.50
LA-GRCAP603440	LeeAgra Ball Cap	Mesh back. Black.	LEEAGRA Quality Equipment 1949	L	\$27.50
LA-GRTEE182870	LeeAgra Tee 1949	Cotton w/logo.	LEEAGRA Quality Equipment 1949	M	\$20
LA-GRTEE182887	LeeAgra Tee 1949	Cotton w/logo.	LEEAGRA Quality Equipment 1949	M	\$20



PRICES

All prices published by LeeAgra, Inc. are suggested prices. LeeAgra, Inc., reserves the right to change prices or specifications without notice. Orders will be processed according to the prices in effect at the date of shipment, unless otherwise notified.

DEALER PRICES

Discounts do not apply to LEE DT 200 tanks, DT 200 options and accessories, or assembled fuel pumps.

FREIGHT

All freight is FOB, LeeAgra, Inc., plant at 117 E. 70th St. Lubbock, TX, unless notified.

TERMS OF SALE

Orders shipped prior to the establishment of credit will be subject to C.O.D. Upon credit approval, net due 30 days from date of invoice.

A finance charge of 1.5% per month will be made on all invoices not paid within the terms of sale.

RETURN OF GOODS

Merchandise may be returned for credit only upon written authorization and may be subject to a 20% restocking fee. An invoice and return authorization number must accompany all returns. Any returned merchandise must be in resalable condition. All shipping and freight charges are the responsibility of the purchaser.

WARRANTY

LeeAgra, Inc., warrants all metal products manufactured by LeeAgra against defects in workmanship or material for (1) full year to the user/purchaser of the product. Proof of purchase is required. All shipping and freight charges are the responsibility of the purchaser.

All other products purchased from other vendors that are sold and distributed by LeeAgra, Inc., carries the original manufacturers' warranty, LeeAgra will assist in providing service and assistance for warranty of these products. All requests for warranty must be in writing and have written authorization from LeeAgra, Inc.





Notes

Blank lined area for notes.



Equipment CATALOG

LeeAgra, Inc. manufactures quality equipment designed to stand the test of time. Since 1949 our diverse product lines have served the agricultural, oil and construction industries. Our products are now sold and serviced worldwide.

Our priority is simple: We are dedicated to manufacturing and delivering innovative and high-quality products while giving full service and support to you, our customer.

Lynn Lee
President

For videos, pictures,
and more please visit:
LeeAgra.com

(800) 825-3346
(806) 687-5790
Sales@LeeAgra.com
Parts@LeeAgra.com

LeeAgra, Inc.
117 E. 70th St.
Lubbock, TX 79404

